

SEK-18 SV MA LP STR55 PR-IN 16P PL3

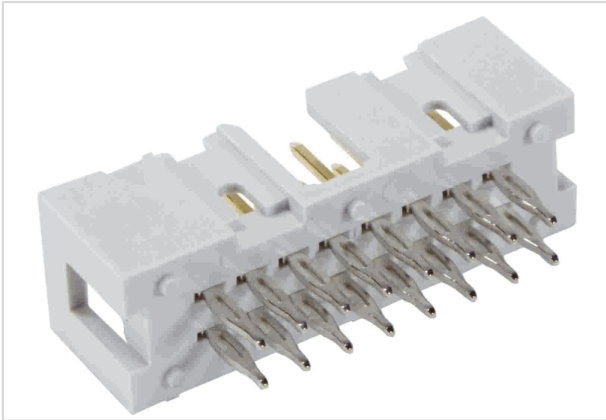

Image is for illustration purposes only. Please refer to product description.

Part number	09 18 516 7329
Specification	SEK-18 SV MA LP STR55 PR-IN 16P PL3
HARTING eCatalogue	https://b2b.harting.com/09185167329

Identification

Category	Connectors
Series	SEK Low-profile
Element	Male connector
Description of the contact	Straight

Version

Termination method	Press-in termination
Connection type	PCB to cable PCB to PCB
Number of contacts	16
Termination length	5.5 mm

Technical characteristics

Contact rows	2
Contact spacing (termination side)	2.54 mm
Rated current	1 A
Insulation resistance	$>10^9 \Omega$
Contact resistance	$\leq 20 \text{ m}\Omega$
Limiting temperature	-55 ... +105 °C
Insertion and withdrawal force	$\leq 48 \text{ N}$
Performance level	3 acc. to IEC 60603-13
Mating cycles	≥ 50



Pushing Performance
Since 1945

Technical characteristics

Test voltage $U_{r.m.s.}$	1 kV
Isolation group	IIIa ($175 \leq CTI < 400$)
PCB thickness	1.6 mm +1.6

Material properties

Material (insert)	Thermoplastic resin (PBT)
Colour (insert)	Grey
Material (contacts)	Copper alloy
Surface (contacts)	Noble metal over Ni Mating side Ni Termination side
Material flammability class acc. to UL 94	V-0
RoHS	compliant
ELV status	compliant
China RoHS	e
REACH Annex XVII substances	Not contained
REACH ANNEX XIV substances	Not contained
REACH SVHC substances	Not contained
California Proposition 65 substances	Yes
California Proposition 65 substances	Antimony trioxide Nickel
Requirement set with Hazard Levels	R26

Specifications and approvals

Specifications	IEC 60603-13
UL / CSA	UL 1977 ECBT2.E102079 CSA-C22.2 No. 182.3 ECBT8.E102079
Railway classification	F3/I3

Commercial data

Packaging size	100
Net weight	2.5 g
Country of origin	Romania
European customs tariff number	85366990
GTIN	5713140029187

Commercial data

eCl@ss

27460201 PCB connector (board connector)

Current carrying capacity

The current carrying capacity of the connectors is limited by the thermal load capability of the contact element material including the connections and the insulating parts. The derating curve is therefore valid for currents which flow constantly (non-intermittent) through each contact element of the connector evenly, without exceeding the allowed maximum temperature.

Measuring and testing techniques acc. to IEC 60512-5-2



- ① Temperature raise
- ② Derating curve
- ③ Derating curve 80%

Recommended configuration of plated through holes

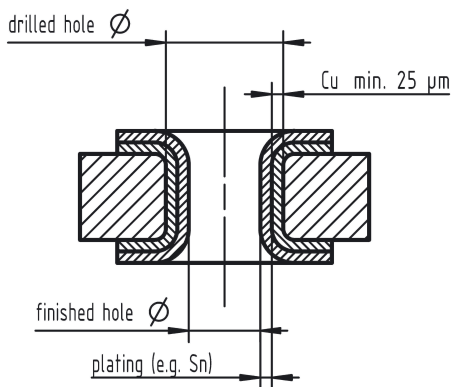

Tin plated PCB (HAL) acc. to EN 60352-5	Drilled hole Ø	1,15-0,03 mm
	Cu	min. 25 µm
	Sn	max. 15 µm
	plated hole Ø	0,94 - 1,09 mm
Chemical tin plated PCB	Drilled hole Ø	1,15-0,03 mm
	Cu	min. 25 µm
	Sn	min. 0,8µm
	plated hole Ø	1,00 - 1,10 mm
Gold /Nickel plated PCB	Drilled hole Ø	1,15-0,03 mm
	Cu	min. 25 µm
	Ni	3 - 7 µm
	Au	0,05 - 0,12 µm
Silver plated PCB	Drilled hole Ø	1,15-0,03 mm
	Cu	min. 25 µm
	Ag	0,1 - 0,3 µm
	plated hole Ø	1,00 - 1,10 mm
Copper plated PCB (OSP)	Drilled hole Ø	1,15-0,03 mm
	Cu	min. 25 µm
	plated hole Ø	1,00 - 1,10 mm

In addition to the hot-air-level (HAL) other pcb surfaces are getting more important. Due to their different properties, such as mechanical strength and coefficient of friction we recommend the above mentioned configuration of pcb through holes.